

INSTRUCTION MANUAL

PUB type

Open Center Pull Lock Chuck



DANGER

- This instruction manual is for production engineers and maintenance personnel in charge of operation of this product. When a beginner uses this product, receive instructions from experienced personnel, the distributor or our company.
- Before installing, operating or maintaining this equipment, carefully read this manual and the safety labels attached to the equipment. Failure to follow these instructions and safety precautions could result in serious injury, death, or property damage.
- Store this manual near equipment for future reference.
- If any questions related to safety arise about this manual, please confirm them with the distributor or our company.

Kitagawa Corporation

77-1, Motomachi, Fuchu-shi, Hiroshima, 726-8610, Japan

Tel. +81-847-40-0561

Fax. +81-847-45-8911

Preface

This manual provides detailed information about how to safely and correctly use the power chuck (PUB200 type) for a lathe.

Before starting to use this power chuck, read this manual carefully and always follow the instructions and warnings in "**Important Safety Precautions**" and "**Precautions for Use**" at beginning of the manual. Failure to follow these precautions could result in a serious accident.

Terms and Symbols Used for Safety Messages

In this manual, precautions for handling that are considered especially important are classified and displayed as shown below depending on the damage of risk including the seriousness of the harm that could result. Please sufficiently understand the meanings of these terms and follow the instructions for safe operation.

Safety Alert Symbol

The triangle is the safety alert symbol used to alert you to potential safety hazards that could result in injury or death.



Indicates a hazardous situation which, if you not avoided, will result in death or serious injury.



Indicates a hazardous situation which, if you not avoided, could result in death or serious injury.



Indicates a hazardous situation which, if you not avoided, could result in minor or moderate injury.



Indicates instructions which, if not avoided, could result in damage to the equipment or a shortened work life.

Liability and How to Use this Manual

This product is suitable for gripping a workpiece on the lathes or rotary tables. This product is equipped with the jaws to clamp the workpiece and they operate by means of a rotary cylinder. For any other applications, please contact us.

Our company will not assume responsibility for injury, death, damage, or loss resulting from not following the instructions in this manual.

There are countless things that cannot or should not be done, and it is impossible to cover all of them in this manual.

Therefore, do not perform any actions unless they are specifically allowed in this manual. If any questions related to safety arise about operation, control, inspection and maintenance which are not specified in this manual, please confirm them with our company or distributor before performing them.

Guarantee and Limitation of Liability

The guarantee period of this product is 1 year after delivery.

Use the parts delivered by Kitagawa Corporation for all the parts including consumable parts. We will not assume responsibility for injury, death, damage, or loss caused by usage of parts not manufactured by Kitagawa Corporation. Additionally, if parts other than genuine parts manufactured by Kitagawa Corporation are used, this guarantee will be completely invalid.

The chuck and cylinder from Kitagawa Corporation should be used together. If you must use a part not made by Kitagawa, check with us or our distributor to be sure it is safe to do so. We will not be responsible for injury, death, damage or loss caused by use of a chuck or cylinder made by another company unless this use has been approved by Kitagawa or its distributor.

Table of Contents

1. Structural Drawing and Parts List	3
1-1. Type display	
1-2. Structural drawing	
1-3. Scope of product	
1-4. Parts list	
2.  Important Safety Precautions	6
3. Specifications	12
3-1. Specifications	
3-2. Relationship between gripping force and rotation speed	
4. Forming and attachment of jaw	15
4-1. Attachment of jaw	
4-2. Forming soft jaw	
5. Usage	17
5-1. Precautions during gripping work with chuck	
5-2. Precautions during gripping work in irregular shape	
5-3. Precautions related to usage of jaw	
5-4. Precautions related to processing	
5-5. Attachment of locator and jig	
6. Maintenance and Inspection	20
6-1. Periodic Inspection	
6-2. Grease lubrication	
6-3. Disassembling	
7. Malfunction and Countermeasures	22
7-1. In the case of malfunction	
7-2. Where to contact in the case of malfunction	
For Machine Tool Manufacturers (Chapter 8)	
8. Attachment	23
8-1. Outline drawing of attachment	
8-2. Manufacturing and attachment of back plate	
8-3. Manufacturing and attachment of draw bar	
8-4. Processing of draw nut	
8-5. Attachment of chuck	
9. Other Information	29
9-1. About standards and orders	
9-2. Information about markings of product	
9-3. About disposal	

1 . Structural Drawing and Parts List

1-1 Type display

Type display as shown below.

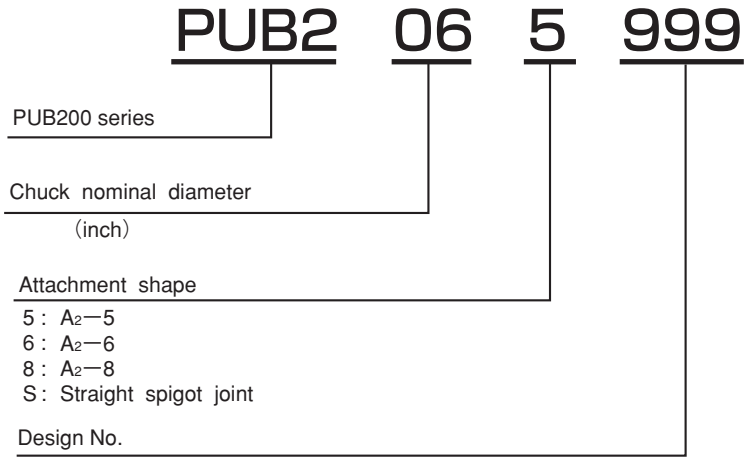

Fig. 1

1-2 Structural drawing

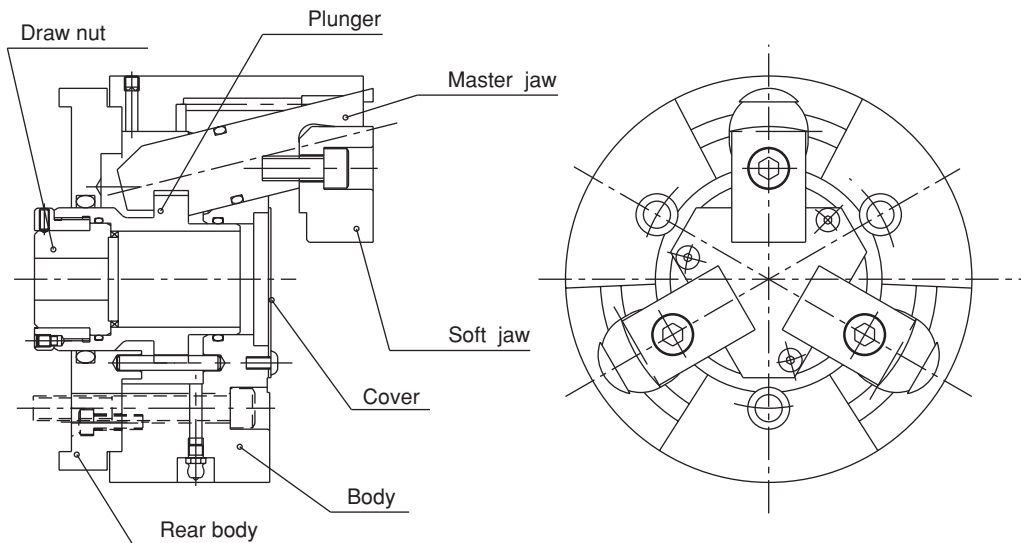

Fig. 2

1-3 Scope of product

This instruction manual is for the chuck part.

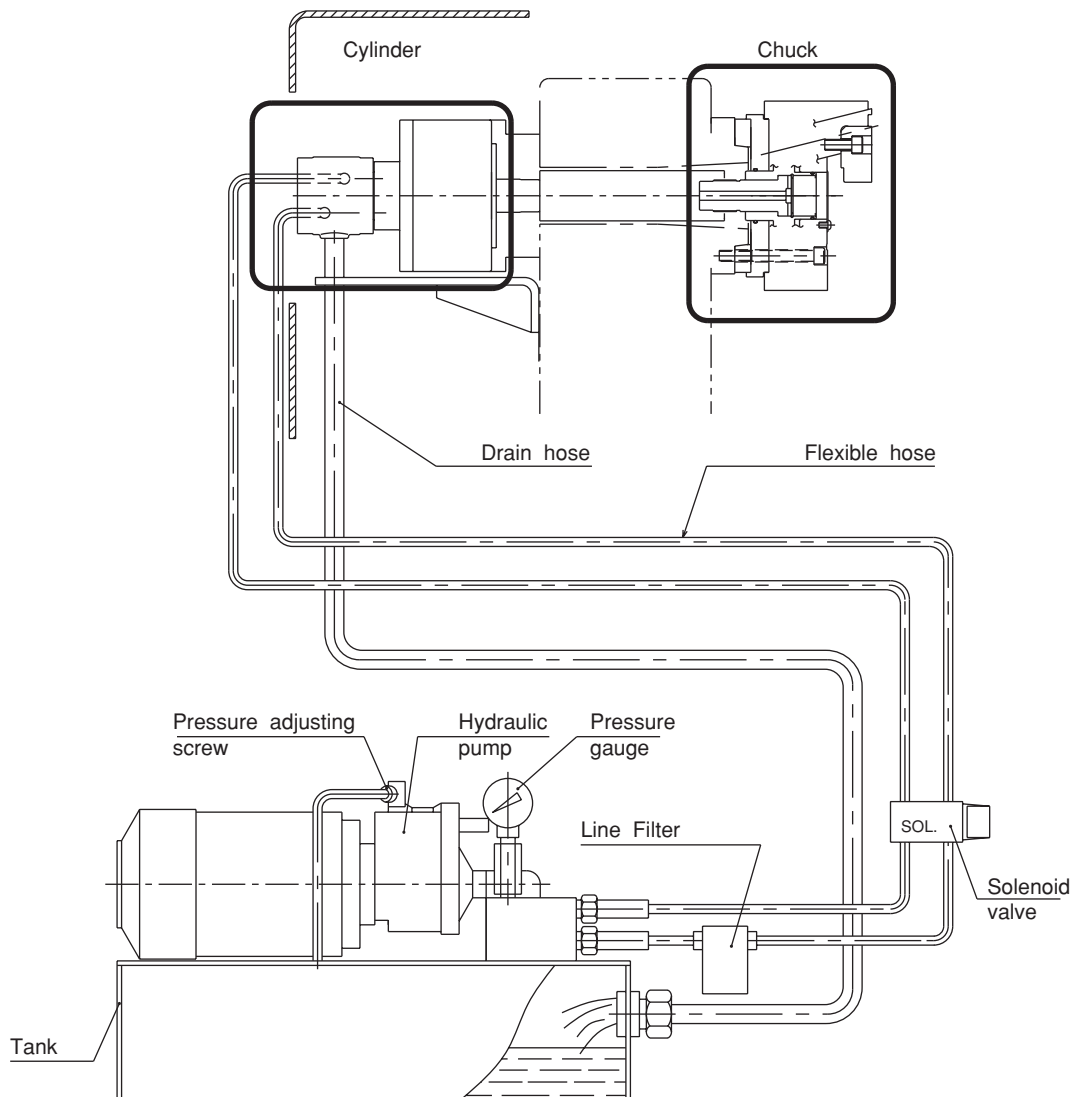

Fig. 3

WARNING

- To prevent the work from flying, safe design, maintenance and erroneous action prevention of the hydraulic system to maintain the gripping force of the chuck is extremely important. Thoroughly read the “Important Safety Precautions” on and after page 6 in this manual.
- As for the cylinder, follow the instruction manual for the cylinder.

1-4 Parts list

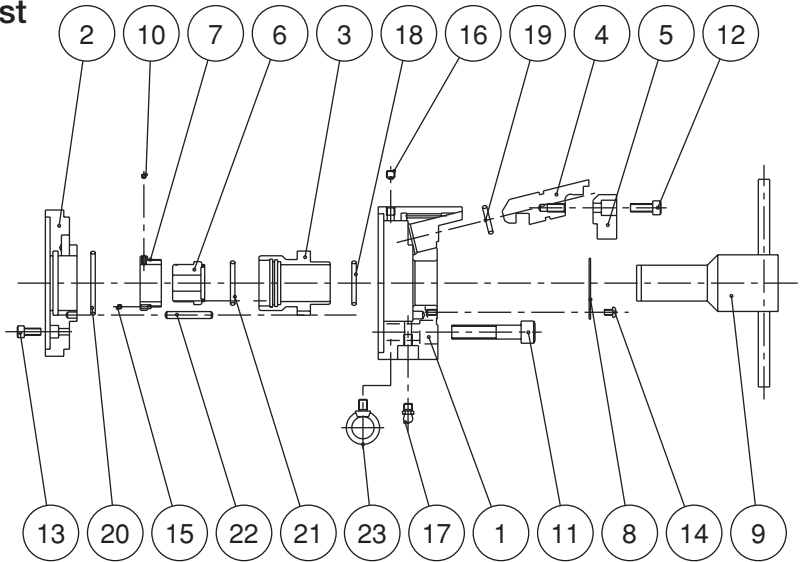

Fig. 4

Table 1

No.	Part name	Quantity	No.	Part name	Quantity
1	Body	1	13	Socket head cap screw	3
2	Rear body	1	14	Machine screw	3
3	Plunger	1	15	Set screw	1
4	Master jaw	3	16	Set screw	1
5	Soft jaw	3	17	Grease nipple	1
6	Draw nut	1	18	O ring	1
7	Plunger nut	1	19	O ring	3
8	Cover	1	20	O ring	1
9	Handle	1	21	O ring	1
10	Ball plunger	1	22	Parallel pin	3
11	Chuck attaching bolt	3	23	Eye bolt	1
12	Jaw attaching bolt	3			

Note: Eye bolt is the standard attached in case of 10 inch or more.

■ Consumable parts

Table 2

No.	Part name	PUB206	PUB208	PUB210	PUB212	Quantity
18	O ring	JIS 2401 G45	JIS 2401 G55	JIS 2401 G80	JIS 2401 G110	1
19	O ring	JIS 2401 P26	JIS 2401 P34	JIS 2401 P39	JIS 2401 P39	3
20	O ring	JIS 2401 P58	JIS 2401 P80	JIS 2401 P102	JIS 2401 P135	1
21	O ring	JASO 2045	JASO 2063	AS5668-236	JIS 2401 G115	1

2. Important Safety Precautions

Important safety precautions are summarized below. Please read this section before first starting to use this product.



DANGER

Failure to follow the safety precautions below will result in serious injury or death.



Turn off main power supply before attaching, inspecting or replacing chuck, and before adding oil.

For All Users

- The chuck may start rotation suddenly, and a part of the body or clothing may be caught.

Main power supply

OFF

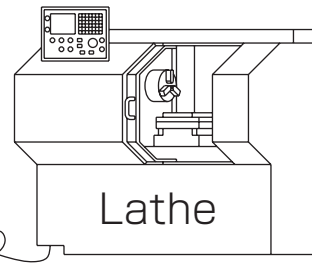
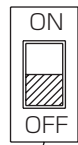

Lathe



Close door before rotating spindle.

For All Users

- If the door is not closed, you may touch the rotating chuck or the work may fly out, which is very dangerous. (In general, the safety interlock function which allows rotation only when the door is the manual mode or the test mode)

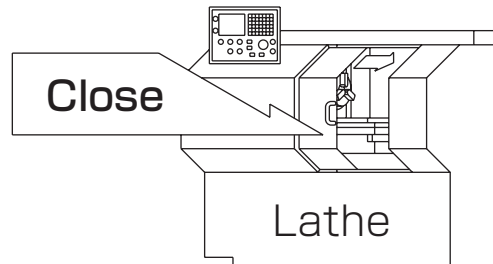

Lathe



During spindle rotation, do not turn off hydraulic pump power supply and do not operate switching valve.

For All Users

- Cutting off hydraulic pressure causes a drop in the gripping force which could result in the work being released and flying out.
- Operating the manual switching valve or solenoid valve will lead to a drop of hydraulic pressure.

Manual switching valve

Jaw close

Jaw open



Solenoid valve

NO

Work

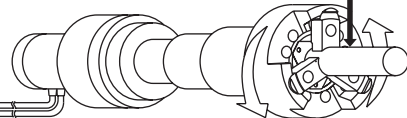



DANGER

Failure to follow the safety precautions below will result in serious injury or death.



Do not allow the rotation speed of the chuck to exceed the maximum allowable speed limit. (Refer to pages 12-14)

For All Users

- If the rotation speed of the chuck exceeds the rotation speed limit, this is very dangerous as the chuck and work will fly out.

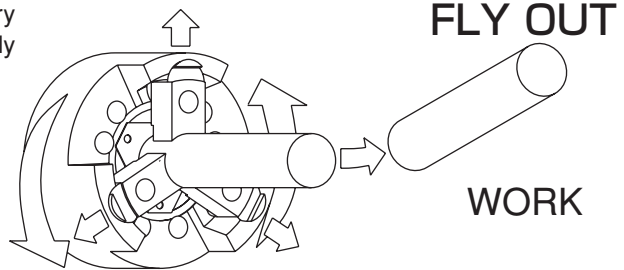

The input force of the chuck (piston thrust, pulling force of the draw bar) must not exceed the allowable maximum input force. (Refer to pages 12-14)

For All Users

- Input must match the specification of the chuck.
- Adjust the hydraulic pressure to the cylinder so that the input force, which determines the gripping force of the chuck, does not exceed.
- Excessive input force can lead to breakage of the chuck, which is very dangerous, as the chuck can work can be damaged and fly out.

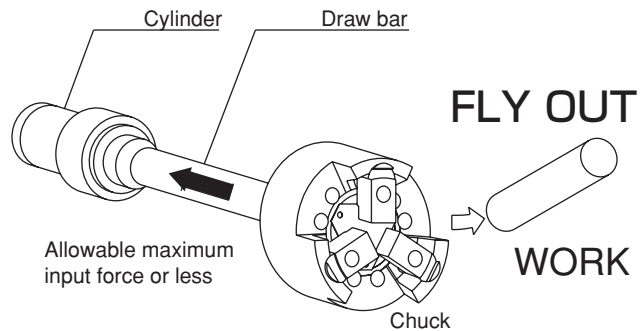

Grip the work-piece after having pushed it to the locator.

For All Users

- Grip the work-piece after having pushed it to the locator. You can't grip the work-piece stably when you use without locator, this is dangerous as the work will fly out.

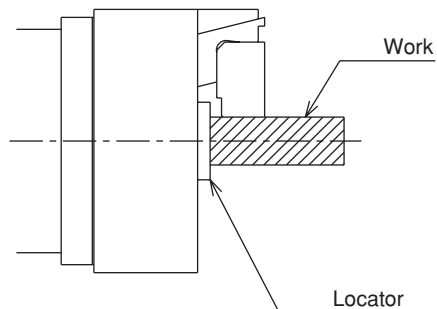



DANGER

Failure to follow the safety precautions below will result in serious injury or death.



Use neither jaw that is taller nor heavier jaw than standard jaw.

For All Users

- The moment hanging to the chuck becomes large when you use taller jaw and this is dangerous as the chuck and work will fly out.
- The centrifugal force becomes large when you use heavy jaw and this is dangerous as the chuck and work will fly out.

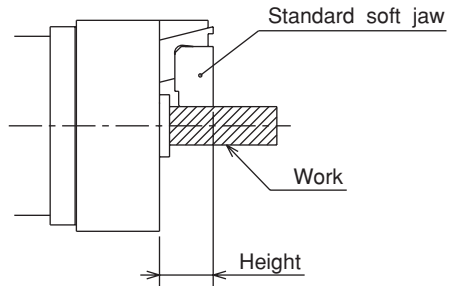

When the protrusion of the work is long, support it with the steady rest or center.

For All Users

- If the protrusion is long, the tip of the work can turn and the work fly out.

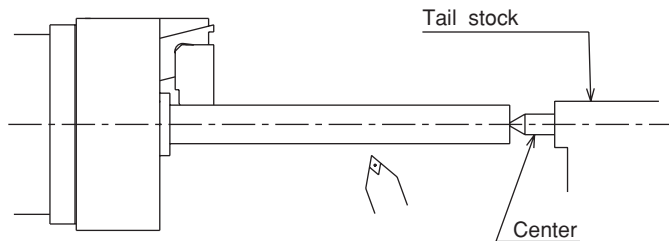

Determine the gripping force required for processing by the machine tool manufacturer or user, and check that the required gripping force is provided before processing. (Refer to pages 12-14 and cylinder manual)

For All Users

- Adjust the hydraulic pressure to the cylinder to obtain the required gripping force. If the gripping force is insufficient, this is dangerous as the work will fly out.

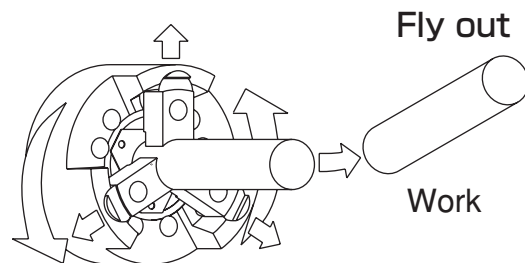



DANGER

Failure to follow the safety precautions below will result in serious injury or death.



Use of a chuck and cylinder that cannot be used together safely may cause the cylinder to break at high pressure resulting in the chuck and work flying out.

For All Users

- Check that the chuck and the cylinder are in the “safe combination” when using at high pressure with our company or the distributor. Especially when the cylinder of our company and a high pressure chuck of other company are combined, confirmation is necessary.
- If one of the abnormal events shown below occurs during operation, immediately stop the machine and consult with our company or the distributor.
 - The work slips.
 - Loss of accuracy.
 - The work begins to chatter.
 - The machine's vibration significantly increases.
 - The gripping force does not rise even if hydraulic pressure is raised.

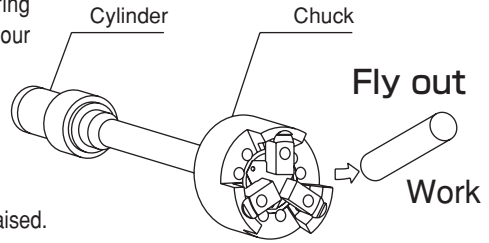

In the case of processing a significant unbalanced work, lower the rotation speed.

For All Users

- Unbalanced work generates dangerous centrifugal forces and the work could fly out.

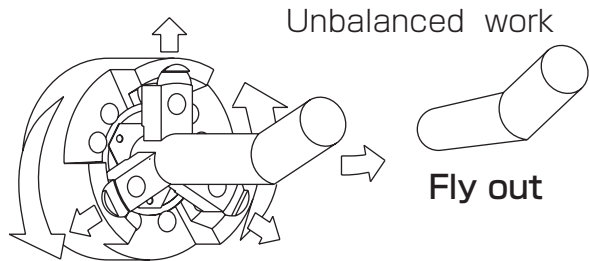

Always tighten the bolts at the specified torque. If the torque is insufficient or excessive, the bolt will break, which is dangerous as the chuck or work will fly out. Use the bolts attached to the chuck, and do not use bolts other than these.

For All Users

- If the torque is insufficient or excessive, the bolt will break, which is dangerous as the chuck or work will fly out.
- Fix the lathe spindle or the chuck when you tighten bolts. Your hand could slip and get injury when you work without fixing the spindle.
- You cannot control the torque by a hex key. You must use a torque wrench for torque control.

Specified torque for socket head cap screw

Bolt size	Tightening torque	Bolt size	Tightening torque
M 5	7.5 N·m	M12	107 N·m
M 6	13 N·m	M14	171 N·m
M 8	33 N·m	M16	250 N·m
M10	73 N·m	M20	402 N·m

Tightening torque
 $T = F \times L$
 $= 127 \times 0.1$
 $= 12.7 \text{ (N} \cdot \text{m)}$

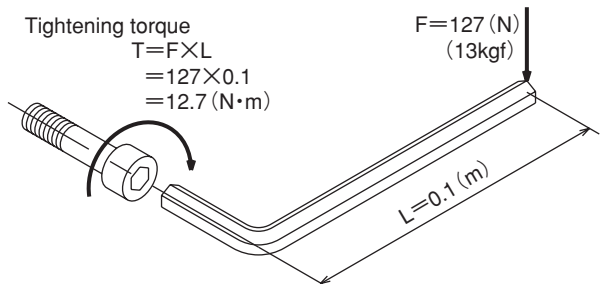

- Tightening torque is moment of force when you tighten a bolt. Tightening torque = $F \times L$.



DANGER

Failure to follow the safety precautions below will result in serious injury or death.



Provide sufficient strength for the draw bar (Refer to pages 25-26).
Provide sufficient screw depth for the draw bar.
Firmly tighten the draw bar.

For Machine Tool Manufactures

- If the draw bar break, the gripping force is instantly lost and this is dangerous as work will fly out.
- If the screw depth of the draw bar is insufficient, the screw will break and the gripping force will be lost instantly, and this is dangerous as work will fly out.
- If the engagement of the screw of the draw bar is loose, vibration may occur resulting in breakage of the screw. If the screw breaks, the gripping force will be lost instantly, which is dangerous as the work will fly out.
- If the draw bar is unbalanced, vibration occurs, the screw is broken and the gripping force will be lost instantly, which is dangerous as the work will fly out.

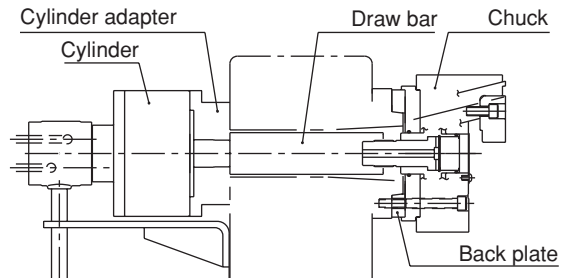

Use a cylinder with a lock valve (safety valve, check valve) incorporated in case of sudden hydraulic pressure drop due to blackout, malfunction of the hydraulic pump, etc. Further, use a solenoid valve with a circuit that retains the gripping position when no current is carried.

For Machine Tool Manufactures

- If the hydraulic pressure suddenly drops due to blackout or malfunction of the hydraulic pump, etc., this is dangerous as work will fly out.
- Lock valve retains the hydraulic pressure inside the cylinder temporarily, when the hydraulic pressure suddenly drops due to blackout or malfunction of the hydraulic pump, etc.

Lightning = Blackout

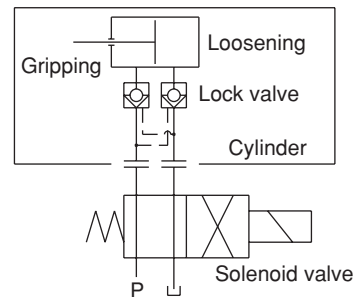
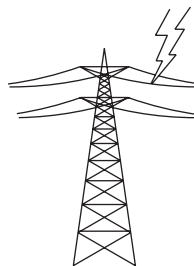

The gripping position must be retained.



WARNING

Failure to follow the safety precautions below could result in serious injury or death.



Do not modify the chuck in a way not permitted by the manufacturer.

For All Users

- It may not only break the chuck but the chuck and the work may fly out, which is dangerous.
- If you attach a locator or jig on the chuck body surface, only process work in an acceptable range (Refer to pages 18-19).

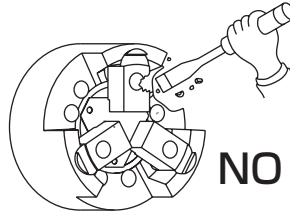

Periodically supply adequate grease (Refer to page 20). Turn off power before adding grease.

For All Users

- Insufficient grease supply lowers the gripping force, causes operation failure due to lower hydraulic pressure, lowers the gripping precision, and causes abnormal wearing and seizing, etc.
- This is dangerous as the work could fly out from a drop in the gripping force.

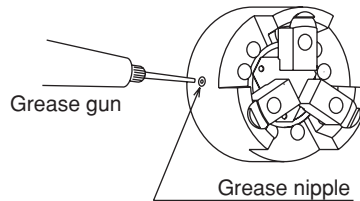

Do not operate the machine after drinking alcohol or taking medication.

For All Users

- Dangerous since these lead to operation mistakes and misjudgment.

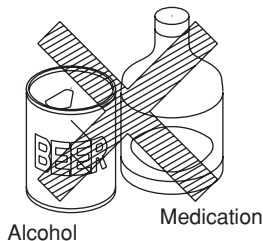

Alcohol

Medication



Do not operate the machine wearing gloves, a necktie, and other loose clothing or jewelry.

For All Users

- Dangerous since it will be caught.

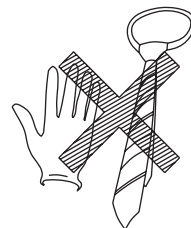

3 . Specifications

3-1 Specifications

Table 3

Type		PUB206	PUB 208	PUB 210	PUB 212
Plunger stroke	mm	10	10	10	10
Jaw stroke (in diameter)	mm	5	5	5	5
Allowable maximum input force	kN (kgf)	18 (1835)	25 (2549)	35 (3569)	35 (3569)
Maximum static gripping force	kN (kgf)	58 (5914)	80 (8158)	100 (10197)	100 (10197)
Allowable maximum rotation speed	min ⁻¹	7000	6000	4500	3600
Gripping range	mm	φ 35~100	φ 35~130	φ 47~160	φ 99~210
Mass (standard soft jaw included)	kg	14.4	25.3	43.5	60.5
Moment of inertia	kg · m ²	0.053	0.140	0.355	0.675
Matching cylinder		Y1020R	Y1225R	Y1225R	Y1225R
Maximum hydraulic pressure (with matching cylinder)	MPa (kgf/cm ²)	2.55 (26)	2.50 (25.5)	3.35 (34.2)	3.35 (34.2)
Balance quality (standard soft jaw not included)		G6.3			
Storing temperature / Operating temperature		-20~+50°C / -10~+40°C			

Reference: 1kN = 101.97kgf 1MPa = 10.197kgf/cm²

When storing this product, the product should be subjected to the antirust treatment and stored in a place free from wetting, condensation, or freeze.

3-2 Relationship between gripping force and rotation speed

1. Maximum static gripping force

The static gripping force is the gripping force when the chuck is at a stop.

The power chuck has a mechanism to convert input force (piston thrust force, draw bar drawing force) from the cylinder to gripping force. Therefore, the gripping force when the allowable maximum input force becomes the maximum static gripping force.

However, the gripping force is different depending on the state of grease lubrication, grease in use, height of the jaw, etc. The maximum static gripping force specified in the specification is the value under the following conditions:

- The Kitagawa standard soft jaw is used as the jaw.
- The attaching bolts of the soft jaw are tightened at the specified torque. (Refer to page 9)
- The numerical values are obtained with the Kitagawa gripping force meter . The gripping position is the middle of soft jaw.
- CHUCK GREASE PRO is used. (Refer to page 20).
- A variable displacement pump with the discharge volume of 20 liters/min or more is used as the hydraulic source. The pressure is set by the pressure control equipment of the pump itself, or the pressure reduction valve equipped separately.

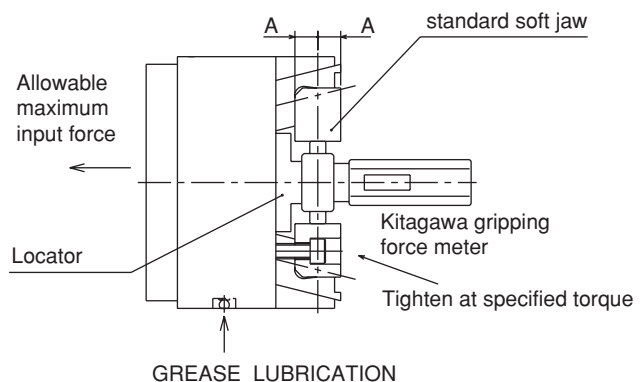

Fig. 5

2. Allowable maximum rotation speed

In the case of outside diameter gripping, when the chuck is rotated, the gripping force lowers due to the centrifugal force of the top jaw. Therefore, the rotation speed when the dynamic gripping force (gripping force during rotation) becomes approximately 1/3 of the maximum static gripping force is set as the allowable maximum rotation speed. The centrifugal force is different depending on the mass of the top jaw and the barycentric position as well as the rotation speed. The allowable maximum rotation speed specified in the specification is the value under the following conditions:

- The Kitagawa standard soft jaw is used.
- Grip the gripping force meter in the center of the jaw stroke.
- The numerical values are obtained with the Kitagawa gripping force meter . The gripping position is the middle of soft jaw.

⚠ DANGER

To avoid serious accidents caused by the chuck or work flying out:

- Determine the gripping force required for processing by the machine tool manufacturer or user, and check that the required gripping force is provided before processing. The gripping force of the chuck must not exceed the maximum static gripping force.
- Determine the rotation speed required for processing by the machine tool manufacturer or user based on the gripping force required for the processing. The rotation speed at this point must not exceed the allowable maximum rotation speed.

NOTICE

- When determining the cutting conditions, refer to pages 13-14.
- Pay attention since the gripping force is different depending on the state of the oil supply, grease in use, height of the jaw, performance of the pump and the pressure reducing valve, piping state, etc.

3. Relationship between gripping force and rotation speed

As the rotation speed becomes higher, the centrifugal force of the jaw increases and the gripping force lowers. The curves displayed in Fig. 6 shows relationships between the rotation speed and the centrifugal force when using the standard soft jaw. The centrifugal force differs significantly depending on the size and shape of the top jaw and the attaching position, therefore, when the rotation speed is high, actual measurement using a Kitagawa gripping force meter is required.

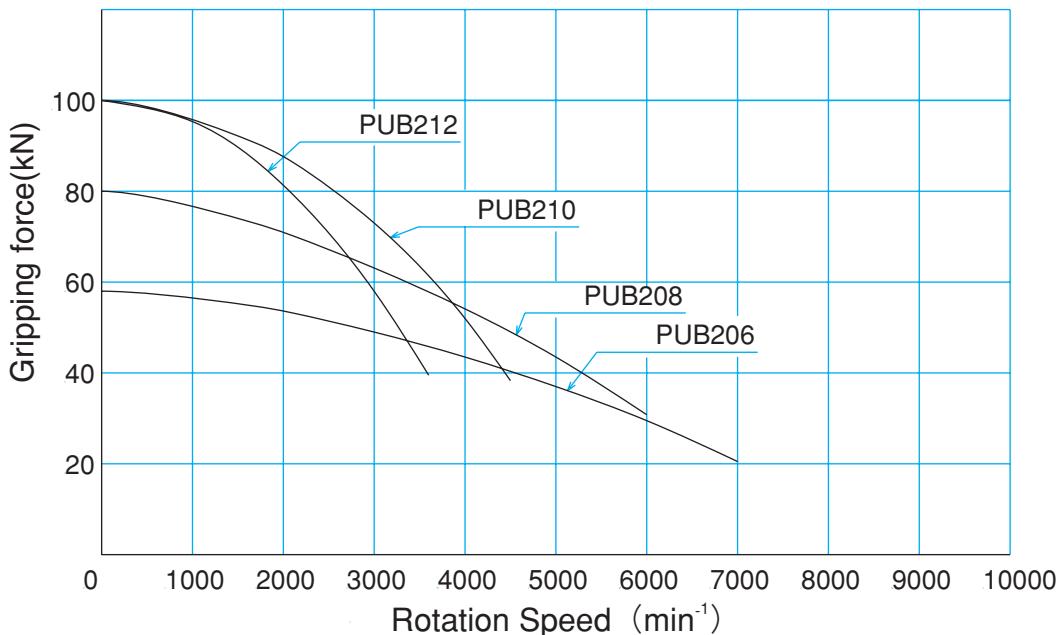

Fig. 6



DANGER

- Use neither jaw that is taller nor heavier jaw than standard jaw.
- The moment hanging to the chuck becomes large when you use taller jaw and this is dangerous as the chuck and work will fly out.
- The centrifugal force becomes large when you use heavy jaw and this is dangerous as the chuck and work will fly out.
- In the case of processing a considerably unbalanced work, lower the rotation speed. The work will fly out and this is dangerous.
- Vibration is generated if there is unbalance due to the work and the jig, etc. Vibration decreases process precision and shortens the working life of the chuck, even possibly breaking it. Correct the unbalance by using a balance weight, etc., or lower the rotation speed for use.
- In the case of heavy cutting at high rotation speed, vibration is easily generated in the same manner as the unbalance of the chuck, therefore, set the cutting conditions appropriate for the dynamic gripping force and machine rigidity.

4 . Forming and attachment of jaw

Prepare the jaw that has the shape, dimensions, accuracy, plane roughness and quenching suitable for processing the work-piece. We recommend following the following method for manufacturing the jaws.

- Forming standard soft jaw on the machine and using a raw material as is. Although it is inferior in durability on gripping face, you can manufacture product immediately.
- Forming standard soft jaw roughly and quenching their gripping face, then finishing on the machine. This is suitable for a mass production, because it excels in durability of the gripping face.
- We recommend you request KITAGAWA for manufacturing, if you manufacture a special shape jaw from scratch without using soft jaw.

4-1 Attachment of jaw



- Use the bolts attached to the chuck, and do not use other bolts. However, if you must use other bolts not provided by Kitagawa, use bolts that have at least a strength classification of 12.9 (10.9 for M22 or more) and be sure they are long enough.
- Do not rotate the chuck so that the jaw attaching bolt is loosened causing the jaw to fly out.
- Never use the chuck when the work-piece is clamped near the stroke end more than 75% of the stroke. When the work-piece is clamped near the stroke end, because the work-piece is not completely gripped or the gripping force is insufficient, this is dangerous as the work will fly out.
- Always tighten the bolts at the specified torque. If the torque is insufficient or excessive, the bolt will break, which is dangerous as the chuck or work will fly out.

Table 4

Bolt size	Tightening torque	Bolt size	Tightening torque
M 5	7.5 N·m	M12	107 N·m
M 6	13 N·m	M14	171 N·m
M 8	33 N·m	M16	250 N·m
M10	73 N·m	M20	402 N·m

4-2 Forming soft jaw

1. Preparation of the plug for forming

- Prepare the plug for forming. The surface roughness of the plug outside diameter is to be approximately 25s, and make a shape with sufficient thickness which does not distort.
- It is convenient to prepare various outside diameter dimensions for dimensions of forming parts.
- It is convenient to process tapping in the center part of the plug and to guide with a bolt, etc.

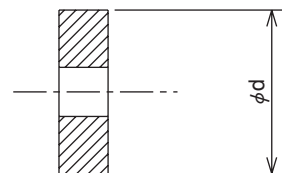

2. Gripping of the plug for forming

- Jaw and locator are detached.
- Fit the plug for forming to the chuck and fix the jaws temporarily with jaw attaching bolt. Set hydraulic pressure to 0.4 - 0.5 MPa and grip the plug. Then push the plug to chuck evenly so that the plug does not tilt.
- Tighten the jaw attaching bolts by specified torque in a state as is. If the temporary jaws fixing is not tight enough, the jaw are lifted when gripping the plug. The plug will not be set correctly.
- Unclamp the chuck and set the hydraulic pressure to the working condition. Then grip the plug again. Then push the plug to chuck evenly so that the plug does not tilt.

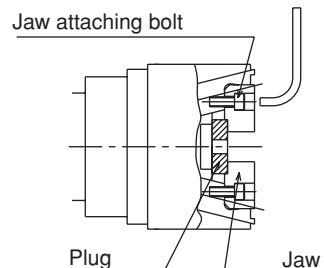

3. Forming

- Process the gripping part (dimension ϕD) of the work in the state that the plug is kept gripped. The ϕD part is to be approximately the same diameter (H7) as the diameter of the gripping part of the work, and process to be surface roughness at 6s or less.
- Set the hydraulic pressure during forming the same as during processing of the work, or slightly higher.
- When the plug distorts, lower the hydraulic pressure or change the plug into a shape which does not easily distort.

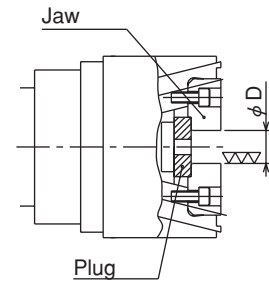

4. Trial cutting

- Remove the plug for forming and attach the locator and the jigs necessary, then grip the work to check the jaw stroke.
- Implement trial cutting to check the process precision and that there is no slip, etc.
- When the gripping contact of the jaw is stronger in its forefront part, the work-piece can be gripped better with less runout at end of the work-piece.

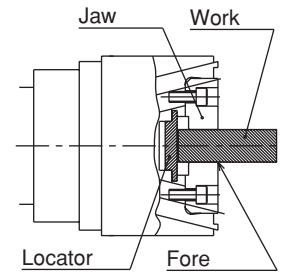

WARNING

- Grip the plug for forming when you form the soft jaw. If you do not, the jaw is rotated by the cutting force, this is dangerous as the jaw will fly out.

NOTICE

- The gripping force, retracting motion and accuracy become stable when the gripping center height becomes as low as possible.
- When the jaw is not finished on the machine or it is finished on another machine, the contact for the work-piece becomes worse, thus resulting in an unstable retracting motion or reducing the gripping accuracy.
- When finishing the jaw without touching the plug for forming to the chuck surface or locator datum end face, the gripping accuracy may be impaired.
- When the gripping position of the plug for forming is near the gripping face of work-piece as much as possible, the gripping accuracy becomes stable.
- When the jaw finished on the machine is removed from the chuck once, the gripping accuracy becomes low as compare with when it is attached as is.
- Do not mistake the numbers marked on jaw.
- If the rigidity of the plug for forming is insufficient, the gripping accuracy becomes low or stroke position becomes out of order.

5 . Usage

This product is a device to fix a work-piece when it is processed by the lathe machine or the rotary table. The rotary cylinder closes the jaw and fixes a work-piece so that it does not move during processing. The chuck opens the jaw after having processed it and remove a work-piece.

NOTICE

- When replacing the top jaw, carefully clean the jaw attaching face with the master jaw. Failure to do this may cause a precision failure.
- Set the hydraulic pressure according to the shape of the work and the cutting conditions. Pipe shape work, etc., may be distorted if they are tightened at a high gripping force.

5-1 Precautions during gripping work with chuck

DANGER

- When gripping a work with the chuck, do not get fingers or hands become caught. This could cause crushed or cut fingers and hands.

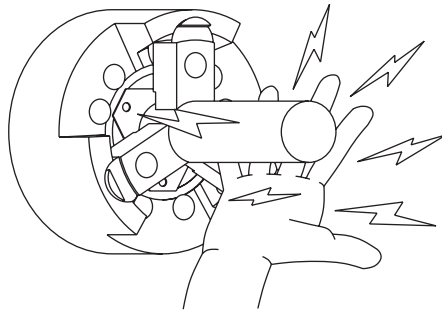

5-2 Precautions during gripping work in irregular shape

DANGER

- Cast metal, pitched shape or taper shape cannot be gripped.
- If the protrusion of the work is long, support it with a center or the steady rest. If the protrusion is long the tip of the work turns, and this is dangerous as the work will fly out.

5-3 Precautions related to usage of jaw

DANGER

- If a soft jaw other than one made by Kitagawa Corporation is used, the engagement will be inferior, and the master jaw will be deformed, the gripping precision will worsen, and the work will fly out due to gripping failure, which is dangerous.
- Do not use the soft jaw by welding to join for extension. The jaw will break due to insufficient strength, and this is dangerous as the work will fly out.

5-4 Precautions related to processing

DANGER

<1> Unbalance

- In the case of processing largely unbalanced work, lower the rotation speed. The work will fly out and this is dangerous.
- Vibrations are generated if there is unbalance owing to the work or the jig, etc. Vibration not only will impart a negative influence on the process precision but also the endurance of the chuck being remarkably shortened, and the chuck may break. Correct the unbalance using balance weights, etc., or lower the rotation speed for use.
- Heavy cutting at high rotation speed easily generates vibration in the same manner as chuck unbalance, therefore, set cutting conditions appropriate for the dynamic gripping force and machine rigidity.

<2> Interference, contact, impact

- Before starting work, check that the top jaw, locator, work, etc., and the tool and the tool post, etc., do not interfere at low rotation and then start processing.
- Do not allow anything to impact the chuck, jaw, and the work. The chuck will break and this is dangerous as the chuck and work will fly out.
- If the tool and the tool post contact the chuck or the work due to malfunction or tape mistake, etc., and impact is given, immediately stop the rotation, and check that there are no abnormalities in the top jaw, master jaw and bolts of each part, etc.

<3> Coolant

- Unless coolant with a rust preventive effect is used, rust will occur inside the chuck and gripping force drop may result. The work will fly out due to the gripping force drop and this is dangerous.

5-5 Attachment of locator and jig

The locator is required for the PUB200 chuck. The PUB200 chuck grips the work-piece in the radial direction and presses the work-piece to the locator simultaneously. Prepare the locator that has the dimensions, accuracy, materials and quenching suitable for processing the work-piece.

DANGER

- Grip the work-piece after having pushed it to the locator. You can't grip the work-piece stably when you use without locator, this is dangerous as the work will fly out. (The black thin cover for the center of the chuck is not a locator. This is temporary protection for the hole.)

- Since the runout of the locator datum end face remarkably influences the finishing accuracy of the work-piece, the datum end face requires that it has sufficient hardness and accuracy. To improve the accuracy of the datum end face, we recommend that the locator is finished with it attached to the chuck after quenching.
- In the case of attaching the locator and the jig on the chuck body surface, tap or drill a hole in the additional process range specified in Fig.7.

DANGER

- The chuck can be modified only in the manufacturer permissible range. This will not only break the chuck but the chuck and work may fly out, which is dangerous.
- Provide a countermeasure against flying out (dwell pin, etc.) due to centrifugal force to the locator or the jig, and attach with bolts which have sufficient strength. The locator or the jig may fly out, and this is dangerous.

Shaded part additional process possible range

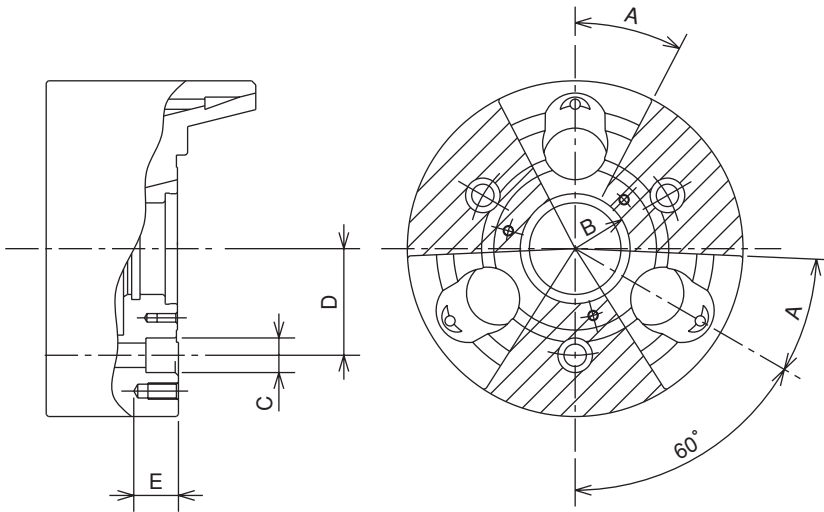

Fig. 7

Table 5

Type	A	B	C	D	E
PUB206	27.5°	27	17	52.4	20 or less
PUB208	25°	33	20	66.7	25 or less
PUB210	25°	45	25	85.7	30 or less
PUB212	22.5°	57	25	85.7	30 or less

A,B,C: Additional process impossible dimension.

E: Processible depth of tapping or drilling a hole.

6. Maintenance and Inspection

6-1 Periodic Inspection

- Add grease at least once a month.
- Fully stroke the jaw before starting work and check the specified stroke.
- Always clean the chuck body or the sliding surface using an air gun, etc., at the end of work.
- Check that the bolts of each part are not loosened at least once every 3 months.
- Disassemble and clean at least once every 6 months or every 100,000 strokes (once every 2 months or more for cutting cast metal).

6-2 Grease lubrication

1. Position to lubricate

- Lubricate using a grease gun from the grease nipple on the body periphery part.
- Read the following lubricating procedures with reference to page 5.
 1. Turn off the main power of the machine before starting work.
 2. Remove the set screw [16] on the body periphery part.
 3. Rotate the chuck so that the hole with the set screw may become it downward. (For the horizontal lathe.)
 4. Move the jaws several times without work-piece to exhaust old grease. At this time, if the coolant or cutting chips are in the chuck, disassemble and clean it. It is necessary to doubt the damage of the seal.
 5. Lubricate using a grease gun from the grease nipple [17] on the body periphery part until grease is exhausted from the hole.
 6. Keep in item 3 above, clamp and unclamp a couple of times without work-piece to discharge extra grease.
 7. Install the set screw [16] certainly.
 8. Clamp and unclamp a couple of times without work-piece again, and check that the No.1 master jaw fully stroke.

2. Grease to use

- Use the designated grease specified in Table 6. If grease other than the designated grease is used, sufficient effect may not be obtained.

Table 6

Genuine product	CHUCK GREASE PRO	Kitagawa genuine product (Kitagawa distributor of each country)
Conventional product	Kitagawa chuck grease	Conventional product
	Molykote EP Grease	TORAY Dow Corning (only inside Japan)
	Chuck EEZ grease	Kitagawa-Northtech Inc. (North American region)
	MOLYKOTE TP-42	Dow Corning (Europe, Asian region)
	Klüberpaste ME31-52	Klüber lubrication (worldwide)

3. Frequency of lubrication

- Add grease at least once a month.
- In the case of high rotation or in the case of using a large amount of water soluble coolant, increase the frequency of lubrication according to the usage conditions.

WARNING

- To keep the chuck running in the best condition for a long time, adequate grease lubrication is necessary. Insufficient grease lubrication causes a drop in the gripping force, operation failure at low hydraulic pressure, drop in gripping precision, abnormal wearing, seizing, etc. The work will fly out due to a drop in the gripping force and this is dangerous.

4. Safety information about grease and anti-rust oil

Applicable range

- Designated grease
- Antirust agent applied to the product at the delivery.

First aid measures

After inhalation: Remove victim to fresh air. If symptoms persist, call a physician.

After contact with skin: Wash off with mild cleaners and plenty of water. If symptoms persist, call a physician.

After contact with eyes: Rinse with plenty of water. If symptoms persist, call a physician.

After inhalation: If large amounts are swallowed, do not induce vomiting. Obtain medical attention.

- Please refer to each MSDS about the grease and the anti-rust oil which you prepared.

6-3 Disassembling

About the exchange of seal

- The seals of each part are consumable parts. When grease leaks out in large quantities, when air breath sound is heard, or when coolant and chips entered the chuck inside, exchange the seals.

Disassembling procedures

Read the following disassembling procedures with reference to page 5.

1. Turn off the main power of the machine before starting work.
2. Loosen the jaw attaching bolt [12] and remove the soft jaw [5].
3. Remove all locators or jigs on the chuck surface.
4. Loosen the draw nut [6] with the handle [9], then loosen the chuck attaching bolt [11] and remove the chuck from the spindle.
5. Loosen the socket head cap screw [13], then remove the rear body [2].
6. Remove the parallel pin. [22]
7. Rotate by 60 degree with the plunger [3] pushed in the maximum, then pull it out after removing the combination with the master jaw [4].
8. Remove the master jaw [4].

Assembling procedures

Assemble again in the reverse procedures of disassembling. Refer to page 5.

Assemble again while sufficiently coating the recommended grease. Lubricate grease after assembling.

(Refer to page 20)

CAUTION

- Use an eyebolt or a hanging belt when attaching and detaching the chuck to and from the machine, as there is a danger of injury or damage if the chuck drops.

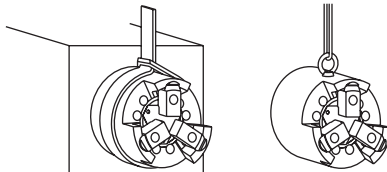

Type	Eyebolt
PUB206	none
PUB208	M10
PUB210	M10
PUB212	M12

WARNING

- Remove the eyebolt or the belt without fail after using. If the chuck is rotated with the eyebolt, etc., attached, they may fly out and this is dangerous.
- Disassemble and clean the chuck at least once every 6 months or every 100,000 strokes (once every 2 months or more for cutting cast metal). If cutting powder or other substances stagnate inside the chuck, it will lead to insufficient stroke and a drop in the gripping force, and this is dangerous as the work will fly out. Check each part carefully and replace any part that is worn or cracked.
- After inspection, apply sufficient grease in the designated areas and reassemble.
- After assembling, measure the gripping force according to the method on page 12, and check that the specified gripping force is obtained.
- If you stop the machine for a long period of time, remove the work from the machine. If you don't, the work can drop due to a drop in the hydraulic pressure or the cylinder can stop or malfunction.
- If you stop the machine or store the chuck for a long period of time, add grease to prevent rust.

7 . Malfunction and Countermeasures

7-1 In the case of malfunction

Check the points specified in the table below and take the appropriate countermeasure.

Table 7

Defective	Cause	Countermeasure
The chuck does not operate.	The chuck inside will break.	Disassemble and replace the broken part.
	The sliding surface is seized.	Disassemble, correct the seized part with oilstone, etc., or replace the part.
	The cylinder is not operating.	Check the piping and the electric system, and if there is no abnormality, disassemble and clean the cylinder.
Insufficient stroke of the jaw.	A large amount of cutting powder is inside.	Disassemble and clean.
	The draw bar loosened.	Remove the draw bar and retighten it again.
The Work slips.	The stroke of the jaw is insufficient.	Adjust so that the jaw is near the center of the stroke when gripping the work.
	The gripping force is insufficient.	Check that the correct hydraulic pressure is obtained.
	The forming diameter of the top jaw is not consistent with the work diameter.	Form again based on the correct forming method.
	The cutting force is too large.	Calculate the cutting force and check that it is suitable for the specification of the chuck.
	Insufficient grease lubrication.	Supply grease from the grease nipple, and open and close the jaw several times without gripping a work.
	The rotation speed is too high. Swinging occurs due to incorrect alignment of cores of work feeder, steady rest, tail stock, etc.	Lower the rotation speed to a speed at which the required gripping force can be obtained. Align the cores sufficiently to eliminate such swinging.
Precision failure.	The outer periphery of the chuck is running out.	Check the end surface run-out and the outer periphery, and retighten the chuck attaching bolts.
	Dust is attached on the attaching part of the master jaw and the top jaw.	Remove the top jaw, and clean the attaching part thoroughly.
	The attaching bolt of the jaw is not tightened sufficiently.	Tighten the top jaw attaching bolt at the specified torque. (Refer to page 9)
	The forming method of the soft jaw is inappropriate.	Is the plug for forming parallel to the chuck end surface? Is the plug for forming not deformed due to the gripping force?
	The height of the top jaw is too high, the jaw is deformed, the jaw attaching bolt is elongated.	Lower the height of the top jaw. (Replace it with the standard size) or check the gripping contact surface and make it uniform.
	The gripping force is too large leading to the work being deformed.	Lower the gripping force in the range possible to process to prevent deformation.



WARNING

- If the chuck failed due to a seizure or breakage, remove the chuck from the machine, following the disassembly steps in page 21. When the jaws and covers cannot be removed due to a blockage of workpiece, do not disassemble forcibly but please contact us or our agent.
- If these countermeasures do not correct the problem or improve the situation. Immediately stop using the machine. Continuous use of a broken product or a defective product may cause a serious accident by the chuck or the work flying out.
- Only experienced and trained personnel should do repairs and fix malfunctions. Repair of a malfunction by a person who has never received instruction from an experienced person, the distributor or our company may cause a serious accident.

7-2 Where to contact in the case of malfunction

In the case of malfunction, contact the distributor where you purchased the product or our branch office listed on the back cover.

For Machine Tool Manufactures

Following pages are described for machine tool manufacturers (personnel who attach a chuck to a machine). Please read following instruction carefully when you attach or detach a chuck to machine, and please sufficiently understand and follow the instructions for safe operation.

8 . Attachment

8-1 Outline drawing of attachment

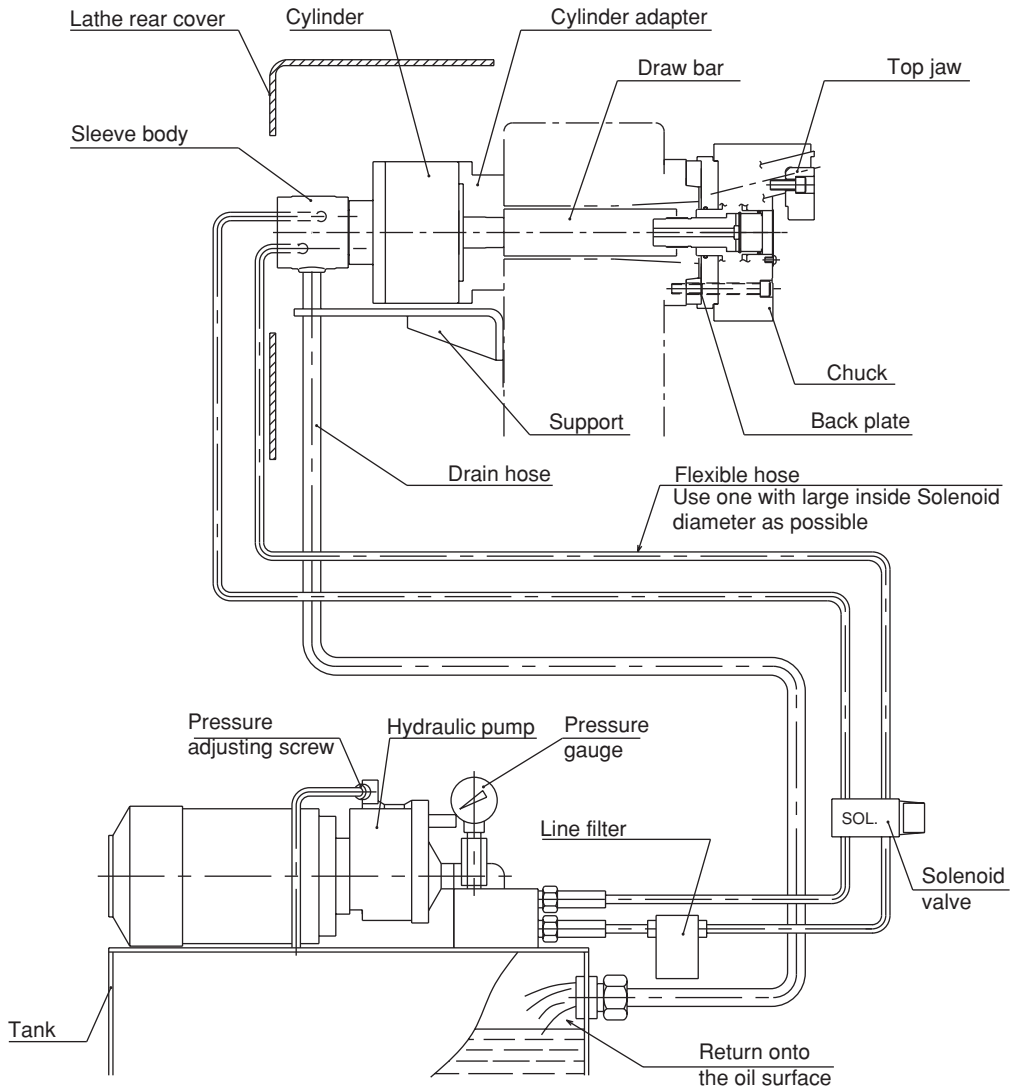

Fig. 8

- Attach the manual switching valve at a position where it is easy to operate for the attaching equipment.
- Install the hydraulic unit at a position where the drain hose is not kinked and the needle of the pressure gauge is easily read.

DANGER

- When other actuators are operated by the same hydraulic pressure source as the cylinder for chuck, be sure that a pressure drop of the cylinder does not occur during use. A hydraulic pressure drop leads to a drop in the gripping force which could allow the work to fly out.
- As to the drain hose
 - Use a transparent vinyl hose for visualization.
 - Provide a stream slope, without air pocket. This will ensure no back pressure.
 - The end of the hose is physically above the oil level. (Refer to Fig.8)
- If the hydraulic oil stagnates inside the cylinder, oil leakage occurs, which may cause a fire.

WARNING

- Install after removing the dust inside the pipe completely.
- Add a filter to the pressure supply line. If foreign matters gets inside the cylinder, this is dangerous since the rotation valve of the cylinder will seize, the hose will tear off, and the cylinder will rotate. This is also dangerous as the work will fly out.
- Always use a flexible hose for the hydraulic piping to the cylinder, and the bending force or tensile force of the pipe must not be applied to the cylinder. Use a pipe inside diameter as large as possible and keep the piping length as short as possible.

NOTICE

- Especially, when a large sized hydraulic unit is used, excessive surge pressure is generated and the gripping force becomes large, therefore, it may result in breakage of the chuck or the lowering of endurance. Restrain the surge pressure by adopting a throttle valve, etc.

8-2 Manufacturing and attachment of back plate

NOTICE

- Process the engagement diameter of the back plate after measuring the actual spindle.
- Run-out of the back plate directly affects the process precision. The end surface run-out of the back plate, spigot joint diameter run-out must be 0.005 mm or less.
- The precision of the processing of the chuck attachment end surface of the back plate and the spigot joint diameter can be raised by processing them after mounting to the installed machine.
- Fig.9 shows the case of the JIS short taper standard.

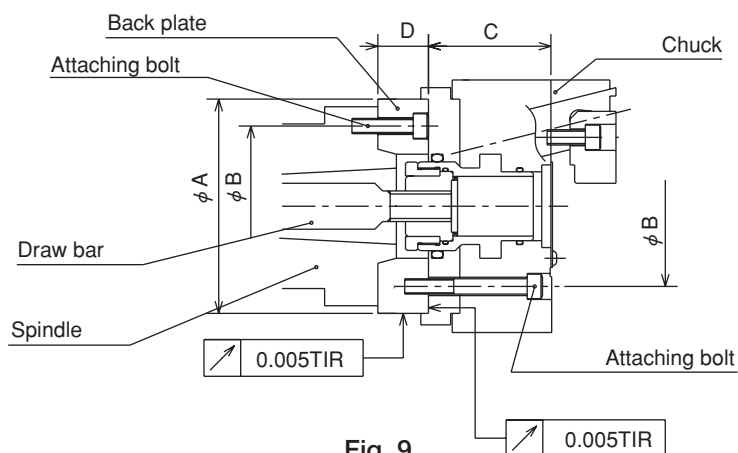

Fig. 9

Table 8

Type	A(G7)	B	C	D(min.)
PUB206	140	104.8	80.5	35
PUB208	170	133.4	93	36
PUB210	220	171.4	103	42
PUB212	220	171.4	103	37



- Always tighten the bolts at the specified torque. If the torque is insufficient or excessive, the bolt will break, which is dangerous as the chuck or work will fly out.
- Use the bolts attached to the chuck, and do not use other bolts. However, if you must use other bolts not provided by Kitagawa, use bolts that have at least a strength classification of 12.9 (10.9 for M22 or more) and be sure they are long enough.

Table 9

Bolt size	Tightening torque	Bolt size	Tightening torque
M 5	7.5 N·m	M12	107 N·m
M 6	13 N·m	M14	171 N·m
M 8	33 N·m	M16	250 N·m
M10	73 N·m	M20	402 N·m

8-3 Manufacturing and attachment of draw bar

Determine the length of the draw bar as shown below.

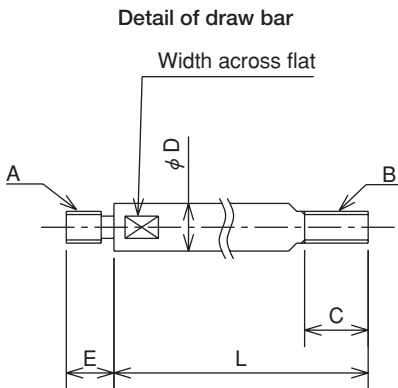

Fig. 10

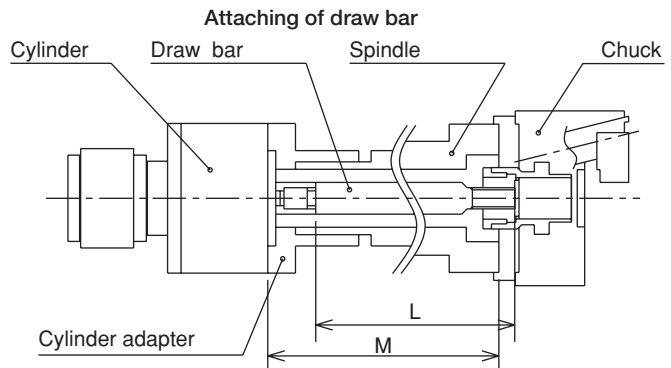

Fig. 11

Table 10

Type	Cylinder	A	B	B (Max.)	C	D	E	L
PUB206	Y1020R	M20	M20	M33x1.5	40	30	30	M-25
PUB208	Y1225R	M24	M24	M45x2.0	40	35	35	M-31
PUB210	Y1225R	M24	M24	M65x2.0	45	35	35	M-29
PUB212	Y1225R	M24	M24	M92x2.0	45	35	35	M-24

The dimension L in Fig. 10 is determined from the distance M between the cylinder adapter and the spindle.

(Example) In the combination of PUB206, Y1020R, and when M=800mm, the draw bar length

L is to be $L = M - 25 = 800 - 25 = 775\text{mm}$.

At the time of the screw process of the dimension A, the precision is to be JIS 6H and 6h, 6g matching the screw of the piston of the cylinder.

DANGER

- Provide sufficient strength for the draw bar. If the draw bar is broken due to insufficiency of the strength, the gripping force will be lost instantly, which is dangerous as the work will fly out.
- Keep the dimension B (Max.) in Fig. 10 for the draw bar and a material with the tensile strength 380MPa (38kgf/mm²) or more must be used.
- The personnel who designed draw bar must judge whether the strength of the draw bar is sufficient for the usage conditions.
- The dimensions and materials specified in this manual do not guarantee that the draw bar will not break under every usage condition.
- If the screw-in depth of the draw bar to the draw nut is insufficient, the screw will break and the gripping force will be lost instantly, which is dangerous as the work will fly out.
- If the engagement of the screw of the draw bar is loose, vibration may occur resulting in breakage of the screw. If the screw breaks, the gripping force will be lost instantly, which is dangerous as the work will fly out.
- If the draw bar is unbalanced, vibration occurs, the screw is broken and the gripping force will be lost instantly, which is dangerous as the work will fly out.

8-4 Processing of draw nut

1. Remove the set screw with a hex key. Loosen the plunger nut with joint handle. Remove the draw nut.
2. Thread draw nut to fit draw bar.
3. Insert draw nut. Screw in the plunger nut with handle. At this time, check O-ring damage carefully.
4. Screw the set screw onto top of plunger nut. Punch the boundary part of the set screw to prevent the its set screw from the loosening.

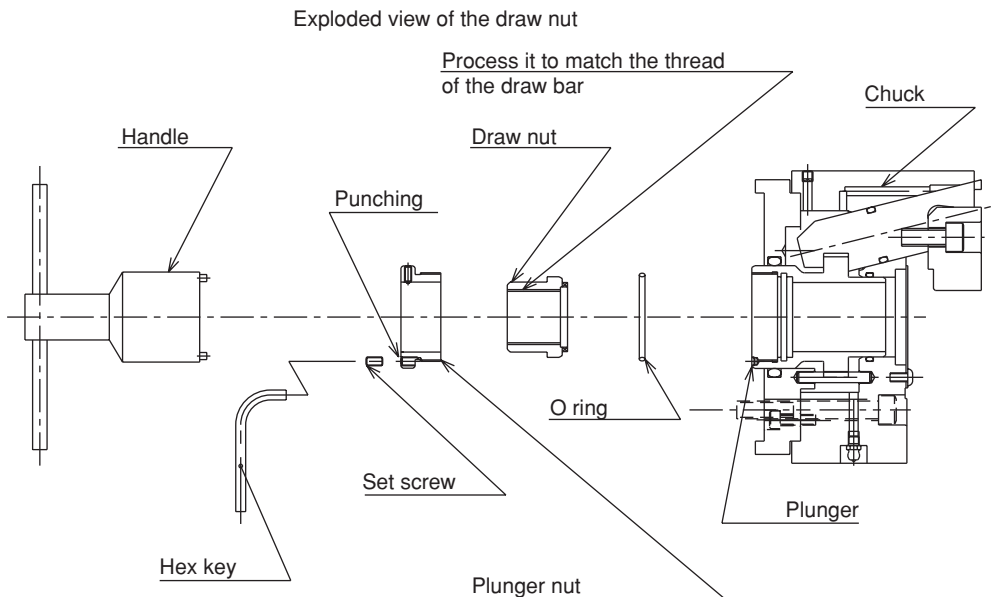

Fig. 12

WARNING

- Punch the boundary part of the hexagon socket set screw to prevent the its set screw from the loosening.
- Do not process the draw nut for screw of the dimensions B (Max.) specified in Table 10 or more. The draw nut may break and the work could fly out.

8-5 Attachment of chuck

1. Attaching the draw pipe to the cylinder

- Apply adhesive onto the screw part of the draw bar, and screw it into the piston rod of cylinder. At this time, refer to the instruction manual for the cylinder for tightening torque.

NOTICE

- When attaching the draw bar to the cylinder, the stopper pin of the piston may break if tightened at the stroke middle position of the piston. In the case of a Y type cylinder, screw it in so that the piston rod is fully in. Follow the explanation of the instruction manual for the cylinder for other items about the cylinder.

2. Attach the cylinder to the spindle (or the cylinder adapter)

- Check the run-out of the cylinder, and if it is normal, attach the hydraulic pipe.
- Move 2 to 3 times at low pressure (0.4 MPa-0.5 MPa, 4 - 5 kgf/cm²) and set the piston at the forward end and turn off the power supply.

CAUTION

- Use an eyebolt or a hanging belt when attaching and detaching the chuck to and from the machine, as there is a danger of injury or damage if the chuck drops.

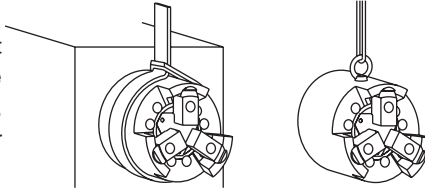

Type	Eyebolt
PUB206	none
PUB208	M10
PUB210	M10
PUB212	M12

WARNING

- Remove the eyebolt or the belt without fail after using. If the chuck is rotated with the eyebolt, etc., attached, they may fly out and this is dangerous.

3. Connect the chuck to the draw bar

- Remove the soft jaw and the cover of the chuck, and connect to the draw bar while turning the draw nut.
- When connecting the draw nut and the draw bar, do not forcibly screw them in if they cannot be screwed smoothly, but check the inclination of the core of the screw, etc.

DANGER

- If the screw-in depth of the draw bar to the draw nut is insufficient, the screw will break and the gripping force will be lost instantly, which will the work to fly out.
- If the engagement of the screw of the draw bar is loose, vibration may occur resulting in breakage of the screw, loss of gripping force and the work flying out.

4. Attach the chuck matching to the attaching surface of the spindle (or the back plate).

- Turn the handle for connection to make a state that the chuck closely contacts the spindle attaching surface of the lathe.
- In the case of adjusting the centering of the chuck, lightly hit the body side face with a plastic hammer.
- Tighten the chuck attaching bolts evenly. At this time, tighten the bolts at the specified torque.

DANGER

- Always tighten the bolts at the specified torque. If the torque is insufficient or excessive, the bolt will break, which is dangerous as the chuck or work will fly out.
- Use the bolts attached to the chuck, and do not use other bolts. However, if you must use other bolts not provided by Kitagawa, use bolts that have at least a strength classification of 12.9 (10.9 for M22 or more) and be sure they are long enough.

Table 11

Bolt size	Tightening torque	Bolt size	Tightening torque
M 5	7.5 N·m	M12	107 N·m
M 6	13 N·m	M14	171 N·m
M 8	33 N·m	M16	250 N·m
M10	73 N·m	M20	402 N·m

5. Adjust the position of the plunger

- Turn the draw nut counter-clockwise up to the full stop, and after this, turn it clockwise for about 270-360 degree to stop it at the position where ratchet hooks. Confirm that the dimension A is within the range shown Fig.13.

6. Attach the jaw and cover or locator and check the run-out of the chuck

- Keep the periphery run-out and the end surface run-out of the chuck at 0.02mm T.I.R or less.

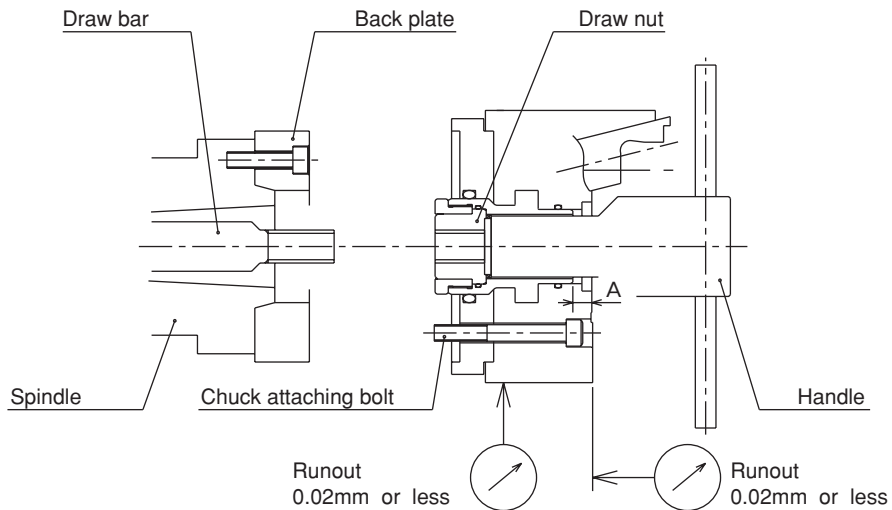

Fig. 13

Table 12

Type	A (mm)
PUB206	6~7
PUB208	6.5~7.5
PUB210	6.5~7.5
PUB212	6.5~7.5

9 . Other Information

9-1 About standards and orders

This product is based on the following standards or orders.

- Machinery directive : 2006/42/EC Annex I
- EN ISO 12100 : 2010
- EN1550 : 1997+A1 : 2008

9-2 Information about markings of product

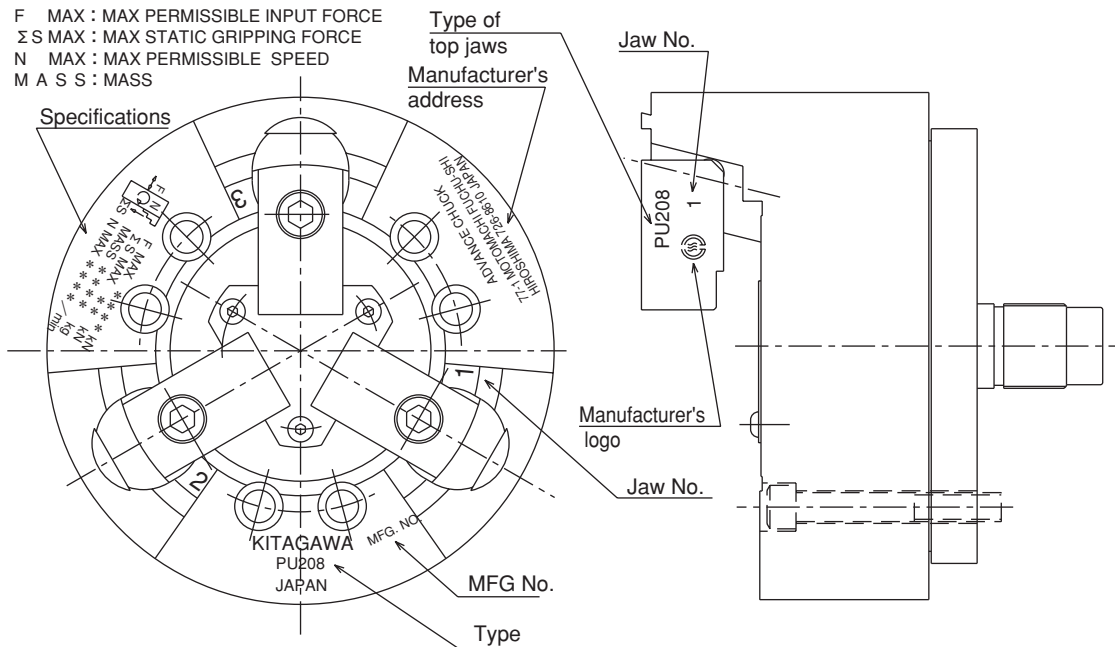

Fig. 14

9-3 About disposal

Ultimate disposal of this product should be handled according to all national laws and regulations.

COPY of Original declaration of incorporation

of partly completed machinery

in accordance with the EC Machinery Directive 2006/42/EC Annex II part 1.B

We hereby declare that the following our product conform with the essential health and safety requirements of the EC Machinery Directive so that the product is to be incorporated into end-machinery. The product must not be put into service until end-machinery has been declared in conformity with the provisions of the EC Machinery Directive 2006/42/EC Annex II part 1.A.

We also declare that the specific technical documentation for this partly completed machinery was drawn up according to the EC Machinery Directive 2006/42/EC Annex VII part B. We engage to transmit the specific technical documentation to the market surveillance authorities on their justified request through the person authorized to compile the documentation in our company.

Product : Advanced chuck

Model : PUB series
(Models PUB206, PUB208, PUB210, PUB212)

Serial number : See original declaration

Authorized complier
in the community : Mark Jones / Financial Director
UNIT 1 THE HEADLANS, DOWNTON,
SALISBURY, WILTSHIRE, SP5 3JJ, UNITED
KINGDOM

The essential health and safety requirements in accordance with the EC Machinery Directive 2006/42/EC Annex I were applied and fulfilled:
1.1.2, 1.1.3, 1.1.5, 1.1.6, 1.3.1, 1.3.2, 1.3.4, 1.5.4, 1.5.8, 1.5.9, 1.5.13, 1.6.1, 1.7.1, 1.7.2, 1.7.3, 1.7.4, 1.7.4.1, 1.7.4.2

The following harmonized standards were applied:
EN ISO 12100:2010, EN 1550:1997+A1: 2008

Signature : See original declaration

Place / Date : See original declaration

Name / Title : Makoto Otsuka / Manager, Technical section 1
Technical department
Kitagawa Global hand Company

Being the responsible person appointed and employed the manufacturer.

Kitagawa Corporation Kitagawa Global hand Company

77-1, Motomachi, Fuchu-shi, Hiroshima, 726-8610, Japan

Tel. +81-847-40-0561

Fax. +81-847-45-8911

■ JAPAN DOMESTIC

Tokyo office	1-405-1, Kita-ku, Yosino-cho, Saitama-shi, Saitama, 331-9634, Japan Tel. +81-48-667-3469 Fax. +81-48-663-4678
Sendai office	4-15-13, Yamatomachi, Wakabayashi-ku, Sendai-shi, Miyagi, 984-0042, Japan Tel. +81-22-232-6732 Fax. +81-22-232-6739
Nagoya office	2-62, Kamitakabata, Nakagawa-ku, Nagoya-shi, Aichi, 454-0873, Japan Tel. +81-52-363-0371 Fax. +81-52-362-0690
Osaka office	3-2-9, Kitagagaya, Suminoe-ku, Osaka-shi, Osaka, 559-0011, Japan Tel. +81-6-6685-9065 Fax. +81-6-6684-2025
Hiroshima office	77-1, Motomachi, Fuchu-shi, Hiroshima, 726-8610, Japan Tel. +81-847-40-0541 Fax. +81-847-46-1721
Kyushu office	7-6-39, Itazuke, Hakata-ku, Fukuoka-shi, Fukuoka, 812-0888, Japan Tel. +81-92-501-2102 Fax. +81-92-501-2103
Overseas office	77-1, Motomachi, Fuchu-shi, Hiroshima, 726-8610, Japan Tel. +81-847-40-0526 Fax. +81-847-45-8911

■ OVERSEAS

America Contact	KITAGAWA-NORTHTECH INC. 301 E. Commerce Dr, Schaumburg, IL. 60173 USA Tel. +1 847-310-8787 Fax. +1 847-310-9484 http://www.kitagawa.us
	TECNARA TOOLING SYSTEMS, INC. 12535 McCann Dr, Santa Fe Springs, CA. 90670 USA Tel. +1 562-941-2000 Fax. +1 562-946-0506 http://www.tecnaratools.com
Europe Contact	KITAGAWA EUROPE LTD. Unit 1 The Headlands, Downton, Salisbury, Wiltshire SP5 3JJ, United Kingdom Tel. +44 1725-514000 Fax. +44 1725-514001 http://www.kitagawa.global/en
	KITAGAWA EUROPE GmbH Borsigstrasse 3, 40880, Ratingen Germany Tel. +49 2102-123-78-00 Fax. +49 2102-123-78-69 http://www.kitagawa.global/de
	KITAGAWA EUROPE GmbH Poland Office 44-240 Zory, ul. Niepodleglosci 3 Poland Tel. +48 607-39-8855 http://www.kitagawa.global/pl
	KITAGAWA EUROPE GmbH Czech Office Purkynova 125, 612 00 Brno, Czech Republic Tel. +420 603-856-122 Fax. +420 549-273-246 http://www.kitagawa.global/cz
	KITAGAWA EUROPE GmbH Romania Office Strada Heliului 15, Bucharest 1, 013991, Romania Tel. +40 727-770-329 http://www.kitagawa.global/ro
	KITAGAWA EUROPE GmbH Hungary Office Dery T. u. 5, H-9024 Gyor, Hungary Tel. +36 30-510-3550 http://www.kitagawa.global/hu
Asia Contact	KITAGAWA INDIA PVT LTD. Plot No.215, 4th Phase, Bommasandra Industrial Area, Bommasandra Jigani Link Road, Bangalore 560 099, Karnataka, India Tel. +91-80-2976-5200 Fax. +91-80-2976-5205 http://www.kitagawa.global/in
	KITAGAWA (THAILAND) CO., LTD. Bangkok Branch 9th FL, Home Place Office Building, 283/43 Sukhumvit 55Rd. (Thonglor 13), Klongton-Nua, Wattana, Bangkok 10110, Thailand Tel. +66 2-712-7479 Fax. +66 2-712-7481
	Kitagawa Corporation (Shanghai) Room 308 3F Building B. Far East International Plaza, No.317 Xian Xia Road, Chang Ning, Shanghai, 200051, China Tel. +86 21-6295-5772 Fax. +86 21-6295-5792 http://www.kiw-sh.com
	Kitagawa Corporation (Shanghai) Guangzhou Office B07, 25/F, West Tower, Yangcheng International Trading Centre, No.122, East Tiyu Road, Tianhe District, Guangzhou, China Tel. +86 20-2885-5276
	DEAMARK LIMITED No. 6, Lane 5, Lin Sen North Road, Taipei, Taiwan Tel. +886 2-2393-1221 Fax. +886 2-2395-1231 http://www.deamark.com.tw
KITAGAWA KOREA AGENT CO., LTD. 803 Ho, B-Dong, Woolim Lion's Valley, 371-28 Gasan-Dong, Gumcheon-Gu, Seoul, Korea Tel. +82 2-2026-2222 Fax. +82 2-2026-2113 http://www.kitagawa.co.kr	
Oceania Contact	DIMAC TOOLING PTY. LTD. 69-71 Williams Rd, Dandenong South, Victoria, 3175 Australia Tel. +61 3-9561-6155 Fax. +61 3-9561-6705 http://www.dimac.com.au

The products herein are controlled under Japanese Foreign Exchange and Foreign Trade Control Act. In the event of importing and/or exporting the products, you are obliged to consult KITAGAWA as well as your government for the related regulation prior to any transaction.