

ISSUE	DATE

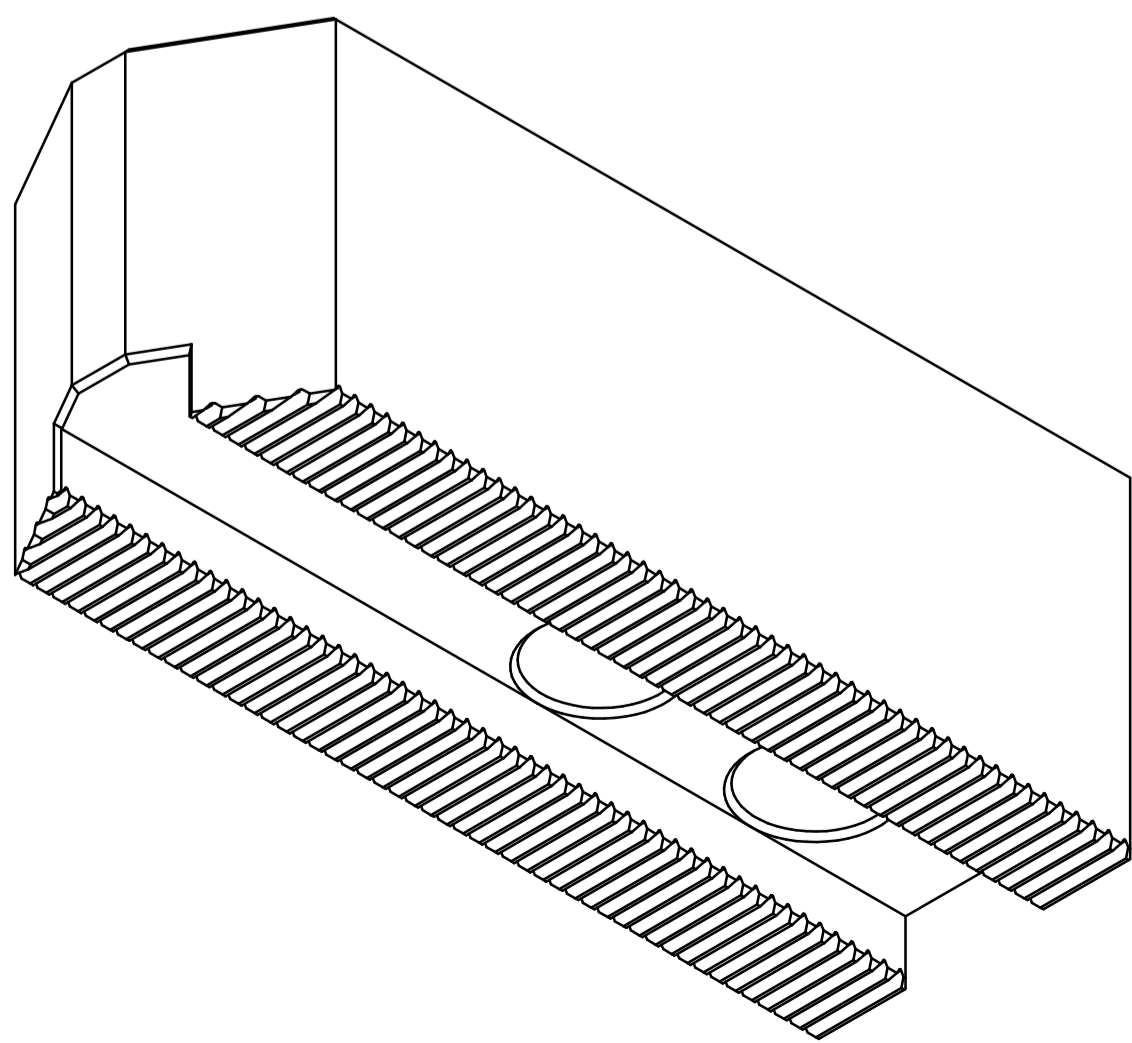
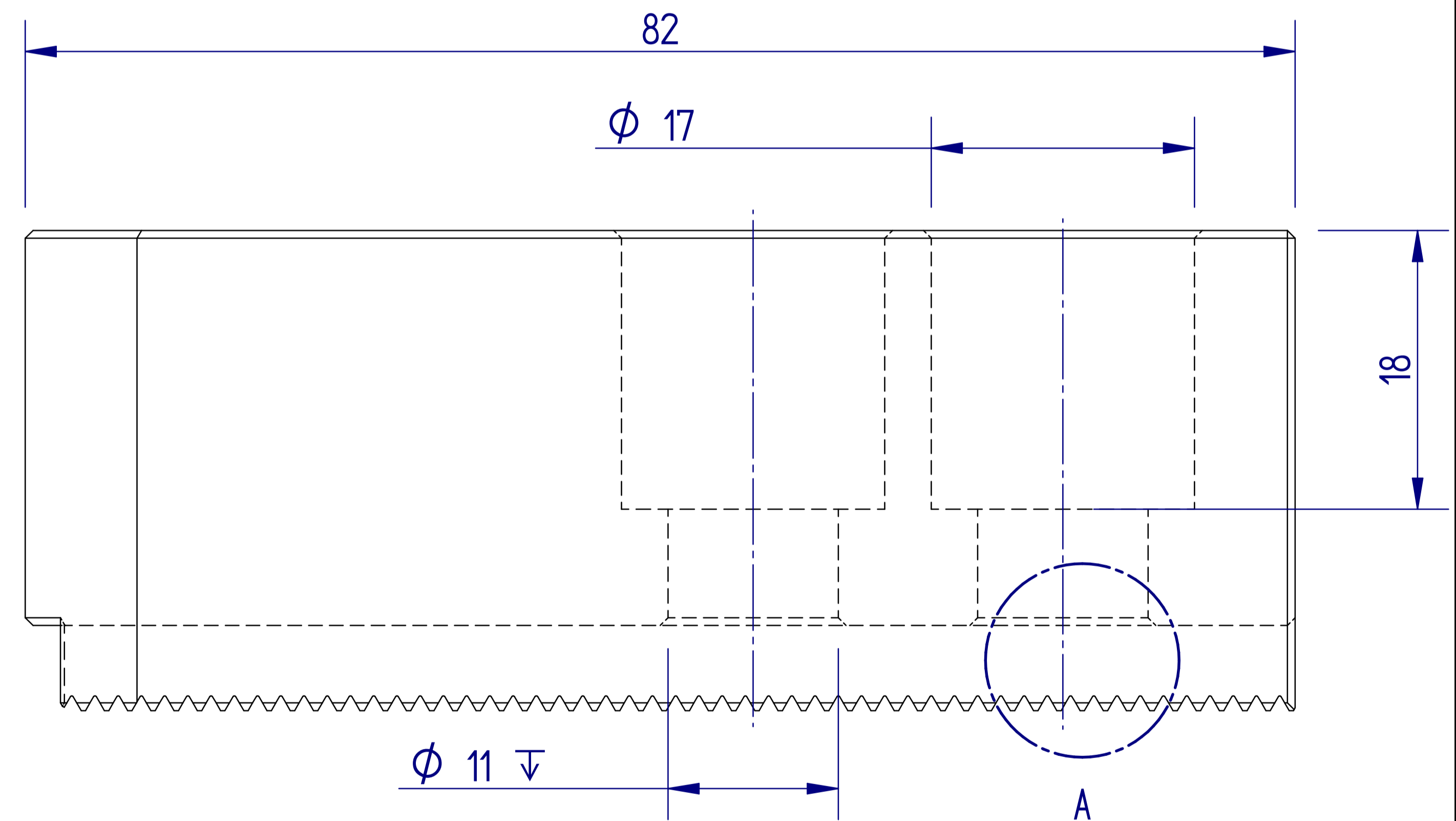
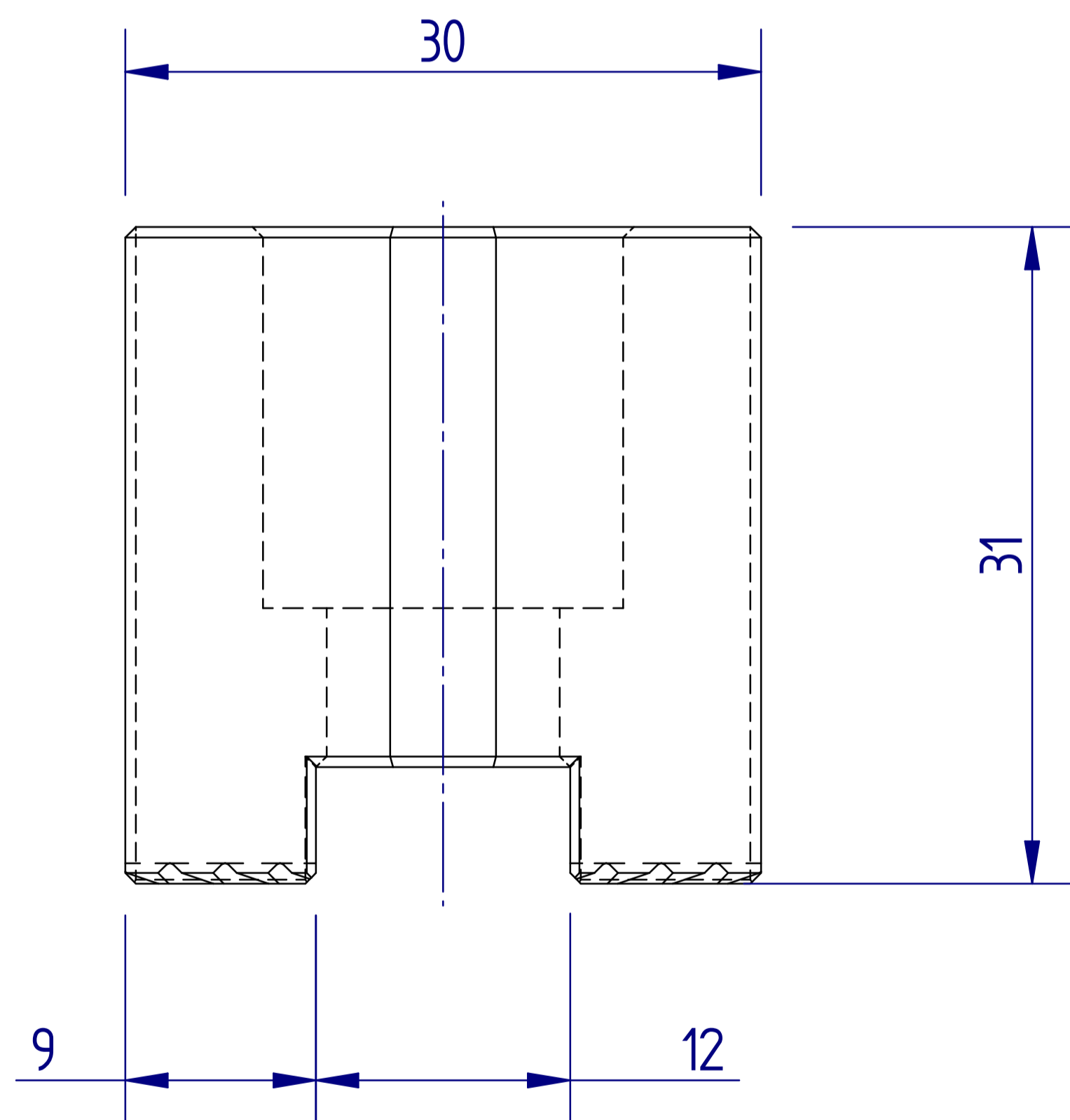
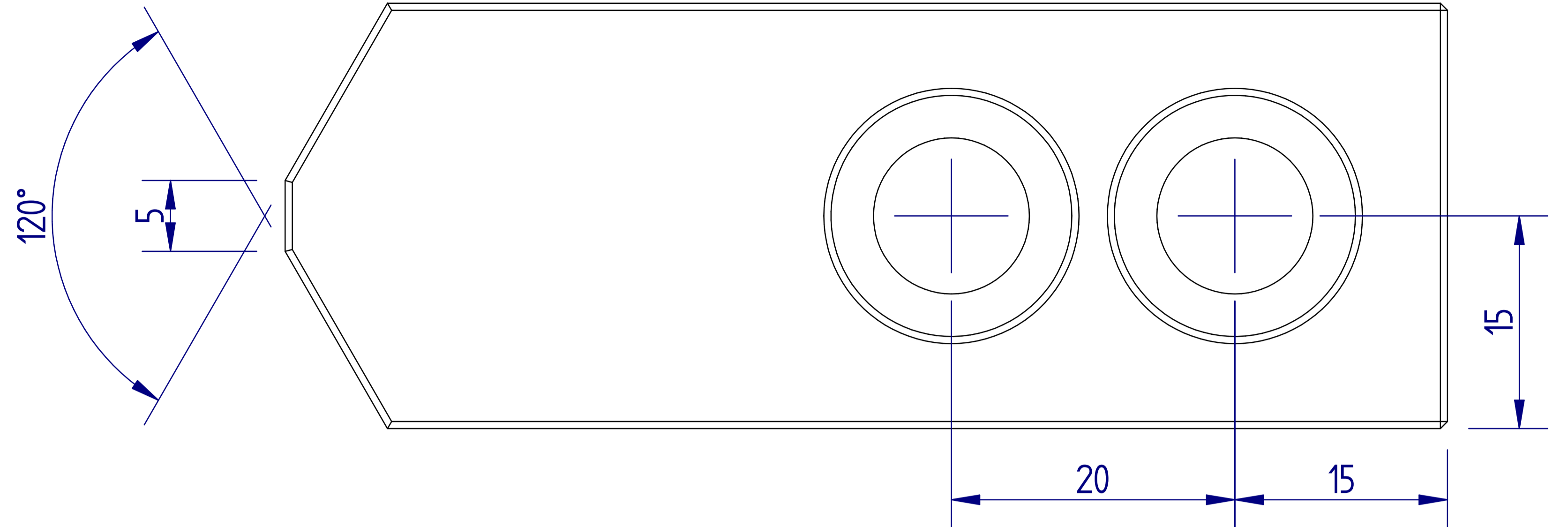
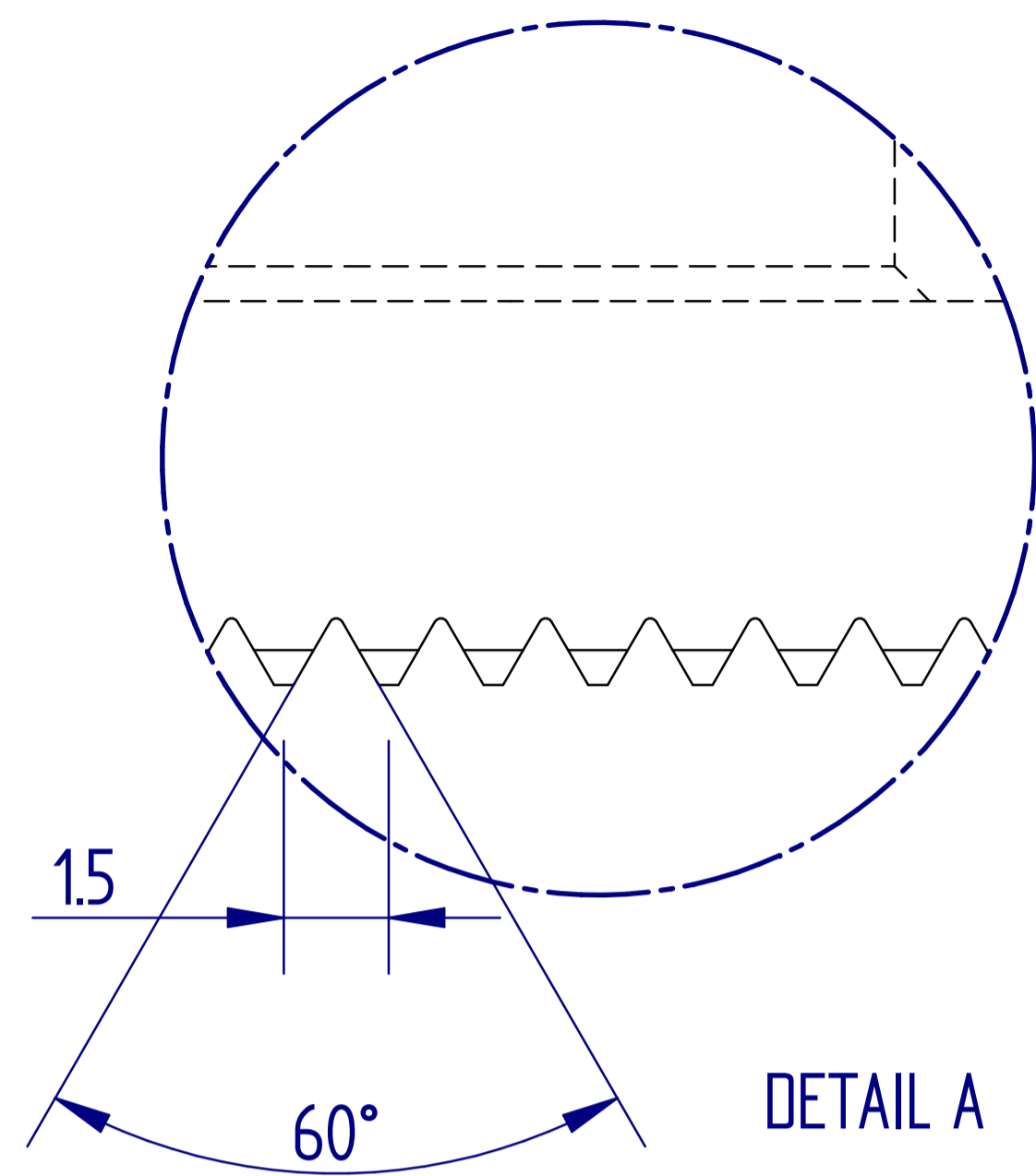
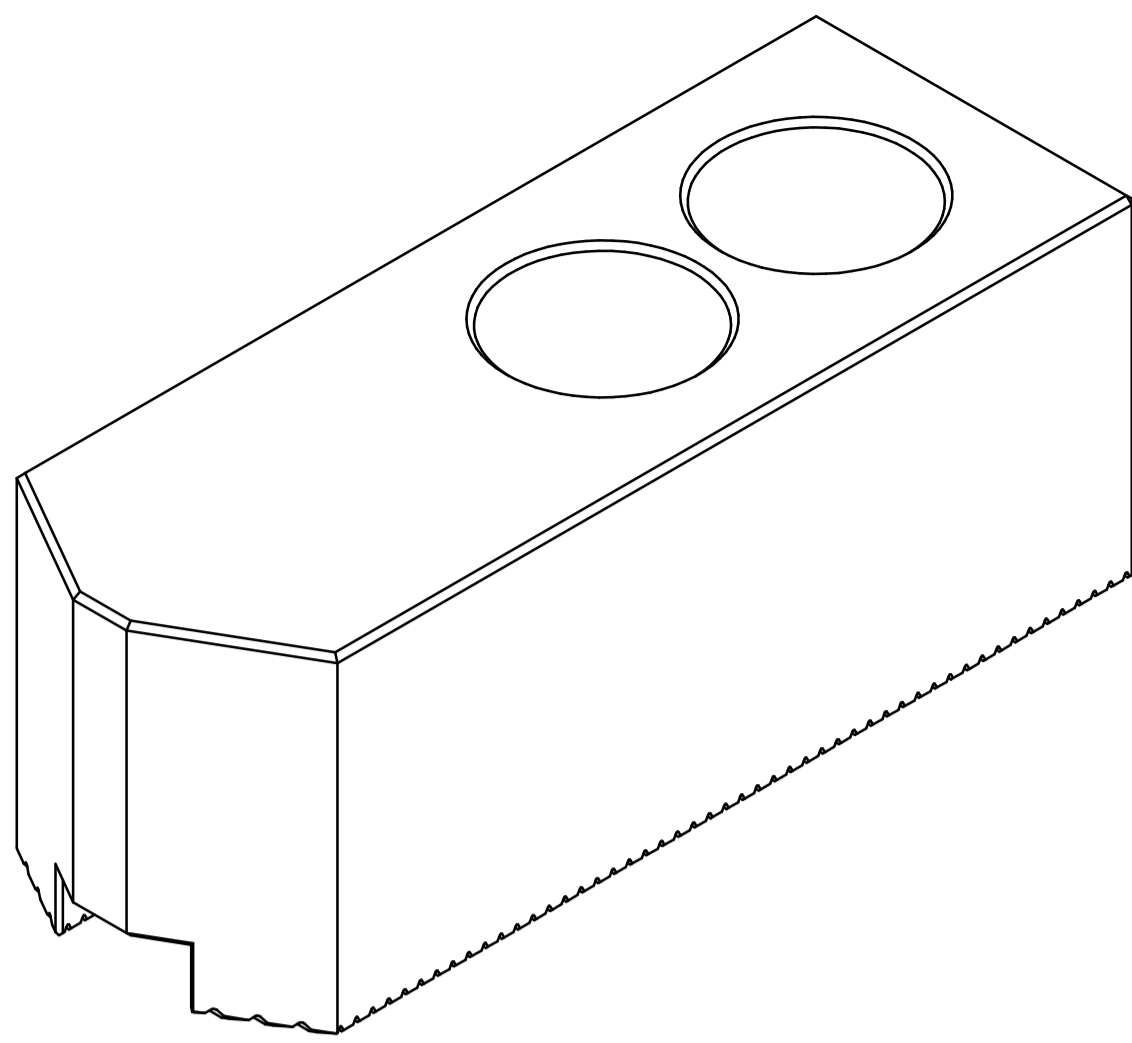

  
 UNIT 1, THE HEADLANDS  
 DOWNTON  
 SALISBURY  
 WILTSHIRE SP5 3JJ

TELEPHONE: 01725 514000  
 TELEFAX: 01725 514001

RANGE AS SPECIFIED	MACHINING TOLERANCES						
	NOMINAL DIMENSION						
	> 0.5 ... 3	> 3 ... 6	> 6 ... 30	> 30 ... 120	> 120 ... 400	> 400 ... 1000	> 1000 ... 2000
	ALL DIMENSION IN mm						
FINE	±0.05	±0.05	±0.1	±0.15	±0.2	±0.3	±0.5
MEDIUM	±0.1	±0.1	±0.2	±0.3	±0.5	±0.8	±1.2
COARSE	±0.2	±0.3	±0.5	±0.8	±1.2	±2	±3
VERY COARSE	—	±0.5	±1	±1.5	±2	±3	±4

DRAWN	M Ereira
DATE	19/01/16
SCALE	
CHECKED	
ISSUE NO.	
DATE	

TITLE	KSJ-06L-82-P Simplified
DRAWING NUMBER	